

MENÙ

kitchen collections

magazine pocket



STOSA
CUCINE

Certifications and Sustainability



MADE IN ITALY

Disegno, progettazione, lavorazione e confezionamento delle cucine Stosa sono effettuati e esclusivamente in territorio italiano.
Design, planning and processing are all performed entirely in Italy.
Le dessin, la conception et la fabrication des produits sont entièrement effectués en Italie.
Los diseños, proyectos y trabajos se realizan todos en Italia.

ISO 9001: 2015 SISTEMA DI GESTIONE QUALITÀ

Il sistema di gestione della qualità Stosa è orientato alla ricerca e all'innovazione di processi e prodotti.
Quality management system Stosa is focused on researching and innovating production processes.
Système de management de la qualité Stosa est orientée vers la recherche et l'innovation de processus et de produits.
Sistema de gestión de calidad de Stosa son la investigación y la innovación de procesos y productos.

CERTIFICAZIONE DI ORIGINE ITALIANA DEL MOBILE

Stosa cucine rispetta tutti i requisiti previsti dalla norma UNI 11674. Le fasi rilevanti del processo di produzione dell'arredo avvengono in territorio italiano.
Stosa cucine complies with all the requirements of the UNI 11674 standard. The relevant phases of the furniture production process take place in Italy.
Stosa cucine est conforme à toutes les exigences de la norme UNI 11674.
Les phases pertinentes du processus de production de meubles se déroulent en Italie.
Stosa cucine cumple con todos los requisitos de la norma UNI 11674. Las fases relevantes del proceso de producción de muebles tienen lugar en Italia.

I MOBILI DELLE CUCINE STOSA SONO CERTIFICATI CARB P2

I mobili delle cucine Stosa sono certificati CARB P2 e sono ricavati da pannelli in materiale completamente riciclato e riciclabile, a bassissimo contenuto di formaldeide. Pannelli utilizzati tipo E1 secondo norma UNI EN 717-1. Il materiale è conforme al mercato americano (USA).
The furniture of Stosa kitchens are CARB P2 certified, they are made of panels produced using fully recycled and recyclable materials containing a very small amount of formaldehyde. Type E1 panels used in compliance with UNI EN 717-1 standards. Material complies with USA market requirements.
Les meubles des cuisines Stosa sont certifiés CARB P2 and sont réalisés avec des panneaux fabriqués avec des matériaux entièrement recyclés et recyclables, à très basse teneur en formaldéhyde. Panneaux utilisés du type E1 selon la norme UNI EN 717-1. Le matériau est conforme au marché américain (USA).
Los muebles de las cocinas Stosa cuentan con la certificación CARB P2 y se obtienen de tableros de material completamente reciclado y reciclable, con bajísimo contenido en formaldehído. Tableros utilizados tipo E1 conforme a la norma UNI EN 717-1. El material es conforme al mercado americano [EE.UU.]

COSMOB QUALITAS PRAEMIUM. CIRCOLARITÀ DEL PRODOTTO ARREDO

Stosa cucine si distingue per i risultati raggiunti negli ultimi anni in termini di impiego sostenibile delle risorse lungo l'intero ciclo di vita del prodotto. La percentuale di materiale che può essere riutilizzata si attesta su valori vicini al 100%.
Stosa Cucine stands out for the results achieved in recent years in terms of sustainable use of resources throughout the entire life cycle of the product. The percentage of material that can be reused is close to 100%.
Stosa Cucine se distingue par les résultats obtenus ces dernières années en termes d'utilisation durable des ressources tout au long du cycle de vie du produit. Le pourcentage de matière pouvant être réutilisée est proche de 100%.
Stosa Cucine destaca por los resultados obtenidos en los últimos años en cuanto al uso sostenible de los recursos a lo largo de todo el ciclo de vida del producto. El porcentaje de material que se puede reutilizar es cercano al 100%.

All'interno della gamma di proposte Stosa è possibile richiedere prodotti certificati FSC®.
Stosa makes FSC® certified products available within its range of cabinets.
Dans la gamme des propositions Stosa, il est possible de demander des produits certifiés FSC®.
Entre la gama de propuestas de Stosa es posible pedir productos certificados en FSC®.



SCAN ME

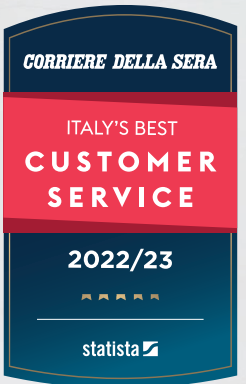

Italy's best customer service 2022/2023

Stosa Cucine ha ottenuto il primo premio "Italy's Best Customer Service 2022/2023" nel settore "Arredo Cucine".

Come dichiarato da il Corriere della Sera e Statista, il miglior servizio clienti nel settore di riferimento è garantito da Stosa Cucine. Si tratta del risultato di un'indagine congiunta che ha coinvolto circa 16.000 consumatori, chiamati a valutare i Brand del cui servizio clienti avevano usufruito nei precedenti tre anni. Stosa Cucine si è aggiudicata il gradino più alto del podio, confermando di essere un'azienda concreta, fortemente orientata al consumatore, e per la quale attenzione al cliente e specializzazione professionale dei progettisti, sono asset fondamentali per garantire un percorso di acquisto di valore, dal pre al post vendita.

Stosa Cucine has been awarded the title of "Italy's Best Customer Service 2022/2023" in the "Kitchen Furniture" sector.

As announced by the Corriere della Sera daily and Statista, Stosa Cucine provides the best customer service in the kitchen furniture sector. This announcement is the result of a survey of 16,000 customers, who were asked to rate their experience with the customer service of different kitchen furniture brands over the last three years. Stosa Cucine was voted best in class, confirming our strong commitment to service. Stosa believes that attention to customers' needs and the use of specialist, professional designers are essential assets for guaranteeing customers a high-added-value experience both before and after purchasing.

Stosa Cucine a remporté le premier prix "Italy's Best Customer Service 2022/2023" (Meilleur service client d'Italie 2022/2023) dans le secteur "Décoration cuisines".

Ainsi que l'ont déclaré le Corriere della Sera et Statista, le meilleur service client du secteur de référence est assuré par Stosa Cucine. Il s'agit du résultat d'une enquête conjointe à laquelle ont participé environ 16 000 consommateurs, invités à évaluer les services dont ils avaient consulté le service client au cours de ces trois dernières années. Stosa Cucine est montée sur la plus haute marche du podium, en se confirmant une entreprise concrète, fortement orientée vers le client et pour laquelle l'attention au client et la spécialisation professionnelle de ses concepteurs sont des atouts essentiels pour assurer un parcours d'achat de qualité de l'avant à l'après-vente.

Stosa Cucine obtuvo el primer premio "Italy's Best Customer Service 2022/2023" en el sector "Mobiliario Cocina".

Como declara la prensa -Corriere della Sera y Statista-, el mejor servicio a la clientela en el sector de referencia es el de Stosa Cucine. Este es el resultado de una encuesta general a la que participaron alrededor de 16.000 consumidores convocados a evaluar los servicios a la clientela de las marcas con las que habían tratado en los últimos tres años. Stosa Cucine se adjudicó el primer puesto del podio, confirmando ser una empresa concreta, sumamente orientada al consumidor, que considera fundamentales la atención al cliente y la especialización profesional de los proyectistas para valorizar todo el proceso de compra, desde la fase de preventa hasta la de posventa.



COLARITÀ DEL PRODOTTO ARREDO
Certificato n°42/2021



FSC® C110382

Flessibilità progettuale e personalizzazione

Le proposte Stosa superano i confini dello spazio cucina e si estendono anche al living. Stosa offre la possibilità di una soluzione unica, con un'estetica e uno stile coerenti.

It's important to choose the Flexibility in terms of planning and customisation. Our furniture extends beyond the boundaries of the kitchen into the living room. Stosa offers coordinated solutions with consistent aesthetics and styles for contemporary homes.

Parce qu'elle offre flexibilité conceptuelle et personnalisation. Les propositions Stosa vont au-delà de l'espace cuisine et s'étendent jusqu'au living. Stosa offre la possibilité d'une solution unique avec une esthétique et un style cohérents.

Es flexibilidad de diseño y personalización. Las propuestas de Stosa van más allá de los límites del espacio de la cocina y se extienden también a la sala. Stosa ofrece la posibilidad de una solución única, con una estética y un estilo en combinación.

2 LINEE: MODERN E CLASSIC

2 lines: modern and classic
2 lignes: modern et classic
2 gamas: moderna y clásica

3 SISTEMI: EVOLUTION SYSTEM LOOK SYSTEM CLASSIC GLAM

3 systems: evolution system, look system and classic Glam
3 systèmes: evolution system, look system et classic Glam
3 sistemas: evolution system look system classic Glam

500 COLORI

500 colours
500 coloris
500 colores

1000 FINITURE

1000 finishes
1000 finitions
1000 acabados

LIVING E TANTI COMPLEMENTI...

Living room furniture and lots of complementary items...
Living et de nombreux compléments...
Mobiliario para la sala y muchos complementos...

STOSA
CUCINE

**OLTRE 100.000
COMBINAZIONI
POSSIBILI**

Over 100,000 possible combinations
Plus de 100.000 combinaisons possibles
Más de 100.000 combinaciones posibles

Stosa è qualità garantita

La qualità delle cucine Stosa nasce da un insieme di scelte virtuose: prima fra tutte la selezione dei migliori materiali e delle migliori finiture che resistono all'uso e al tempo, con ante spesse 23 mm per garantire solidità. Tutti i materiali di scocche, ante, cassetti, top, schienali e zoccoli sono sottoposti a rigorosi controlli per verificarne resistenza e durata. La partnership con i migliori brand di elettrodomestici, di accessoristica e illuminazione interna, di cerniere e guide assicura l'eccellenza dei prodotti.

Caratteristiche standard delle cucine Stosa
Standard features of Stosa kitchens
Caractéristiques standard des cuisines Stosa
Características estándares de las cocinas Stosa

Quality guaranteed by virtuous choices. The quality of our kitchens results from a set of virtuous choices: first and foremost we select the best materials and finishes that are resistant to wear and to the ravages of time, making 23-mm thick doors that guarantee solidity. All the materials used for our carcasses, doors, drawers, tops, back panels and plinths endure strict tests to assess their resistance and durability. We partner with the best brands of household appliances, accessories and interior lighting, hinges and runners to deliver excellent products.

Parce qu'elle a une qualité garantie par des choix vertueux. La qualité des cuisines Stosa naît d'un ensemble de choix vertueux: le premier d'entre eux est sans aucun doute la sélection des meilleurs matériaux et des meilleures finitions qui résistent à l'usage et au temps qui passe, avec des portes de 23 mm d'épaisseur pour en assurer la solidité. Tous les matériaux utilisés pour la fabrication des caissons, des portes, des tiroirs, des plans de travail, des crédences et des socles sont soumis à de rigoureux contrôles pour en vérifier la résistance et la durée. Le partenariat avec les meilleures marques d'électroménagers, d'accessoires, d'éclairage intérieur, de charnières et de coulisses assure l'excellence de nos produits.

Es calidad garantizada por opciones virtuosas. La calidad de las cocinas Stosa proviene de un conjunto de opciones virtuosas: en primer lugar, la selección de los mejores materiales y los mejores acabados que resisten el uso y el tiempo, con puertas de 23 mm de espesor para garantizar la solidez. Todos los materiales de estructuras, puertas, cajones, encimeras, traseras y zócalos son sometidos a rigurosos controles para comprobar su resistencia y durabilidad. La colaboración con las mejores marcas de electrodomésticos, accesorios e iluminación interna, bisagras y guías asegura la excelencia de los productos.

Cerniere garantite per 200.000 CICLI DI APERTURE



Ante AMMORTIZZATA



Hinges guaranteed for 200,000 opening cycles. Charnières garanties pour 200.000 cycles d'ouverture. Bisagras garantizadas para 200.000 ciclos de apertura.

Guide cassetti e cestoni garantiti 60.000 CICLI DI APERTURE



Meccanismi TOP QUALITY



Drawer and deep drawer runners guaranteed for 60,000 opening cycles. Coulisses de tiroirs et de casseroles garantis pour 60.000 cycles d'ouverture. Guías de cajones y gavetas garantizadas para 60.000 ciclos de apertura.

Reggi pensili carico nominale MASSIMO FINO A 70 KG



Carico di RESISTENZA 70 KG



Nominal load for wall unit fixings maximum 70 kg. Suspensions des éléments hauts supportant une charge nominale jusqu'à un maximum de 70 kg. Barras de soporte de los colgantes carga nominal máxima de hasta 70 kg.

Anta SPESSORE 23 MM



Strutture ROBUSTE



Doors are 23 mm thick. Portes de 23 mm d'épaisseur. Puerta de 23 mm de grosor.

TRE PROGETTI

tre modi di interpretare la cucina

Three projects three ways of interpreting the kitchen.
Trois projets, trois modes d'interpréter la cuisine.
Tres proyectos, tres formas de interpretar la cocina.

Progetta con Stosa
 Design with Stosa
 Concevez avec Stosa
 Diseña con Stosa



Evolution System

Natural
 Aliant
 Metropolis
 Color Trend

Look System

Aliant
 Color Trend
 Alevè
 Infinity
 City
 Karma

Classic Glam

Newport
 Tosca
 Beverly
 York
 Bolgheri
 Virginia
 Dolcevita

Zoccolo altezza 8/10/12/15 cm
 H. 8/10/12/15 cm plinth
 Socle hauteur 8/10/12/15 cm
 Zócalo de 8/10/12/15 cm de altura

Colonne zoccolo h.8/10/12/15 cm
 Tall units, H. 8/10/12/15 cm plinth
 Armoires socle hauteur 8/10/12/15 cm
 Columnas zócalo de 8/10/12/15 cm de altura

Zoccolo altezza 10/12/15 cm
 H.10/12/15 cm plinth
 Socle hauteur 10/12/15 cm
 Zócalo de 10/12/15 cm de altura

Zoccolo altezza 12/15 cm
 H.12/15 cm plinth
 Socle hauteur 12/15 cm
 Zócalo de 12/15 cm de altura

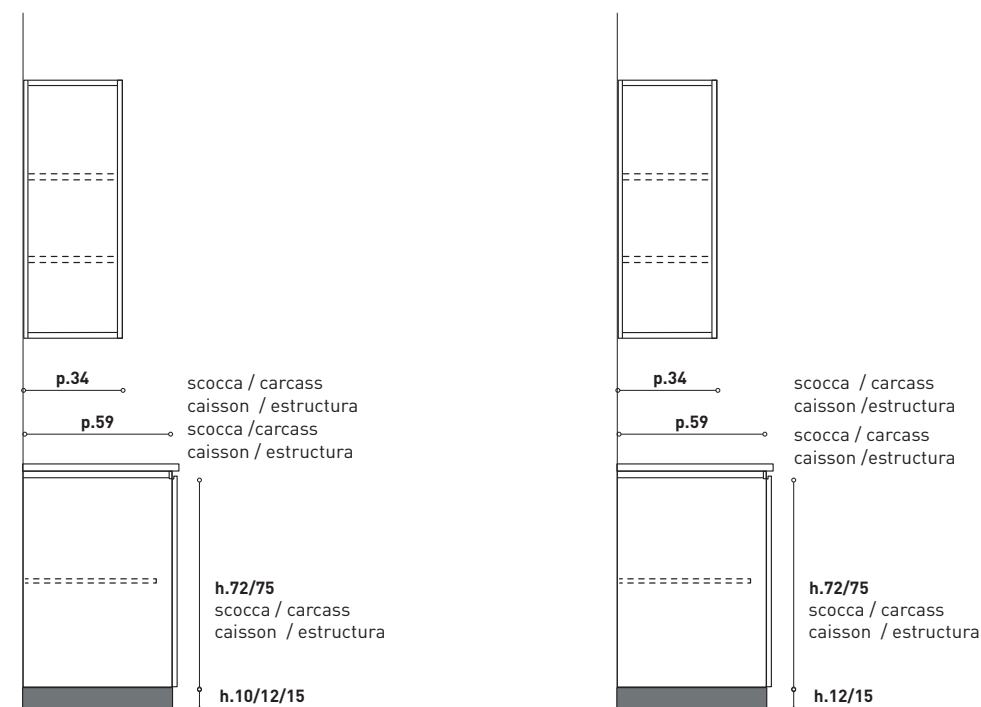
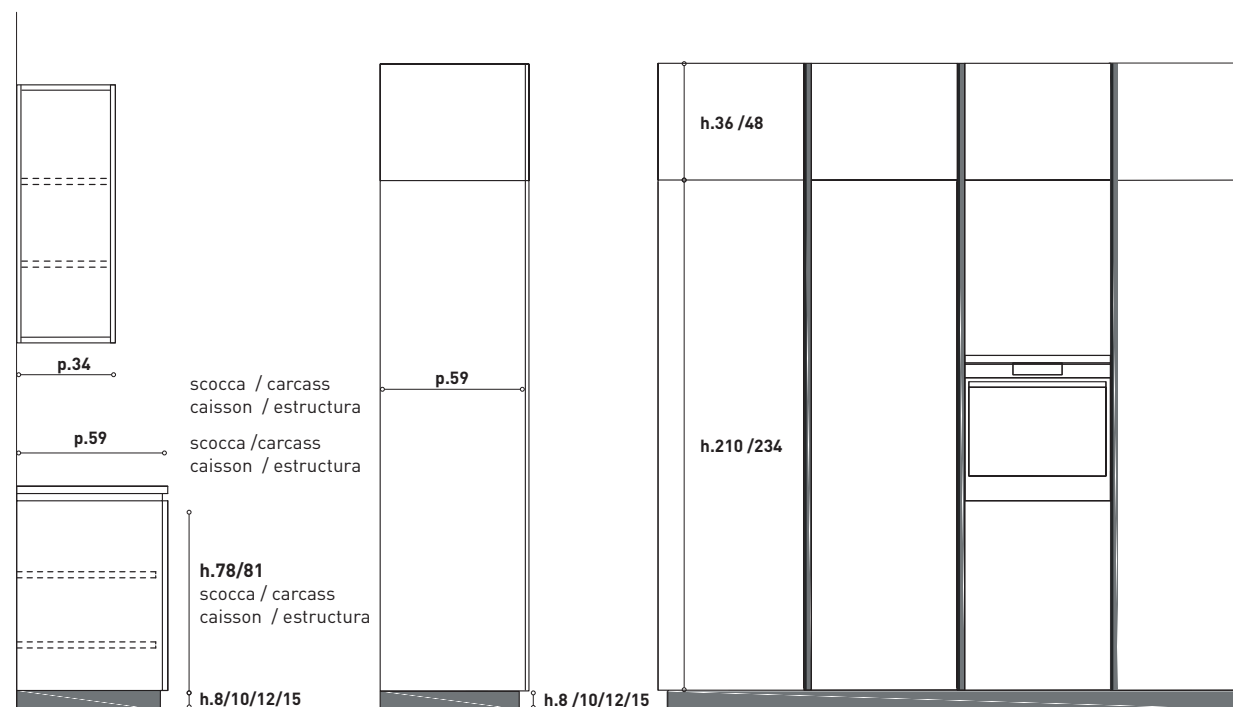

+PLUS EXCLUSIVE PROJECT

Evolution System soluzioni compositive che aumentano lo spazio in cucina.

Evolution System: modules that add space to your kitchen.

Evolution System solutions d'agencement qui augmentent l'espace dans la cuisine.

Evolution System soluciones compositivas que aumentan el espacio en la cocina.



Profondità 75 per basi
75 cm depth for base units
Profondeur 75 pour éléments bas
Profundidad 75 para muebles bajos



Larghezza 75 per base lavastoviglie con vano
75 cm width for a dishwasher base unit with an open shelving
Largeur 75 pour élément bas pour lave-vaisselle avec niches
Ancho 75 para mueble lavavajillas con compartimento



Larghezza 75 per colonna frigo
75 cm width for the tall fridge unit
Largeur 75 pour armoire réfrigérateur
Ancho 75 para columna frigorífico



Larghezza 75 per colonna, ante a filo terra
75 cm width for tall unit with floor-level doors
Largeur 75 pour armoire, avec portes à fleur du sol
Ancho 75 para columna, puertas al ras del suelo



Larghezza 75 per colonna forno per forni XXL o forni 60 con vano laterale
75 cm width for the tall oven unit for XXL ovens or for 60 cm ovens with a side / Largeur 75 pour armoire four pour fours XXL ou four vs de 60 avec niche latérale / Ancho 75 para columna horno para hornos XXL u hornos 60 con compartimento lateral

Evolution System

La modularità che aumenta gli spazi di contenimento in cucina.

Modularity that increases storage spaces in the kitchen.

La modularité qui augmente les espaces de rangement dans la cuisine.

La modularidad que aumenta los espacios de almacenaje en la cocina.



Zoccolo altezza 8 cm

Plinth height 8 cm
Socle hauteur 8 cm
Zócalo de 8 cm de altura

Pensili e basi larghezza 75 cm

75 cm wide wall and base units
Éléments hauts et bas en largeur 75 cm
Colgantes y muebles bajos ancho 75 cm

Basi con terza gola 12+24+36 cm

Base units with a third groove 12+24+36 cm
Éléments bas avec troisième gorge 12+24+36 cm
Muebles bajos con tercera ranura 12+24+36 cm

Natural

evolution system

NOCE ELEGANT, LISCIO E CANNETTATO, LACCATO BROMO LUCIDO.
NOCE ELEGANT, SMOOTH AND RIBBED, GLOSS BROMO LACQUER.
NOCE ELEGANT, LISSE ET CANNELÉ, LAQUÉ BROMO BRILLANT.
NOCE ELEGANT, LISO Y ACANALADO, LACADO BROMO BRILLO.



Natural

evolution system



↑ **ROVERE TERMOCOTTO, LISCIO E CANNETTATO E NEOLITH® CEMENT SATIN.**
THERMO-STRUCTURED ROVERE, SMOOTH AND RIBBED AND SATIN CEMENT NEOLITH®.
ROVERE THERMO-CUIT, LISSE ET CANNELÉ ET NEOLITH® CEMENT SATIN.
ROVERE TERMOCOTTO, LISO Y ACANALADO, NEOLITH® CEMENT SATIN.

Colonne con ante retraibili.

Tall units with retractable doors.
Colonnes avec portes rétractables.
Columnas con puertas retráctiles.

Plus+
Design



Metropolis

evolution system

NOCE EUCALIPTO E PET CACHEMERE OPACO.
NOCE EUCALIPTO AND MATT PET CACHEMERE.
NOCE EUCALIPTO ET PET CACHEMERE MAT.
NOCE EUCALIPTO Y PET CACHEMERE MATE.



Metropolis

evolution system



**PIASENTINA SCURA, CEMENTO DARK
E PET GRIGIO FREDDO OPACO.**

PIASENTINA SCURA, CEMENTO DARK
AND PET GRIGIO FREDDO MATT.

PIASENTINA SCURA, CEMENTO DARK
ET PET GRIGIO FREDDO MAT.

PIASENTINA SCURA, CEMENTO DARK
Y PET GRIGIO FREDDO MATE.



**Plus+
Design**

Cappa Divide

wall - hood / hotte / campana



Aliant

evolution system
look system

VETRO LAVA LUCIDO, PIETRA NEOLITH® BASALT BLACK SATIN.

GLOSS NERO ASSOLUTO GLASS, BASALT BLACK SATIN NEOLITH® STONE .

VERRE NERO ASSOLUTO BRILLANT, PIERRE BASALT BLACK SATIN NEOLITH®

CRISTAL NERO ASSOLUTO BRILALNTE, PIEDRA BASALT BLACK SATIN NEOLITH®.



Aliant

evolution system / look system



**VETRO BROMO LUCIDO, PIETRA NEOLITH®
PIETRA DI LUNA SILK E NOCE ELEGANT
CANNETTATO _**

GLOSS BROMO GLASS, PIETRA
DI LUNA SILK NEOLIGHT® STONE
AND NOCE ELEGANT CANNETTATO.
VERRE SALINA BRILLANT, PIERRE
PIETRA DI LUNA SILK NEOLIGHT®
ET NOCE ELEGANT CANNETTATO.
CRISTAL SALINA BRILLANTE, PIEDRA
PIETRA DI LUNA SILK NEOLIGHT®
Y NOCE ELEGANT CANNETTATO.



**↑ VETRO SALINA LUCIDO, PIETRA
NEOLITH® CALATORAO SILK.**

GLOSS SALINA GLASS,
CALATORAO SILK NEOLIGHT® STONE.
VERRE SALINA BRILLANT, PIERRE
CALATORAO SILK NEOLIGHT®.
CRISTAL SALINA BRILLANTE, PIEDRA
CALATORAO SILK NEOLIGHT®.

Terza gola 12+24+36 cm

Third groove 12+24+36 cm
Troisième gorge 12+24+36 cm
Tercera ranura 12+24+36 cm

**Plus+
Design**



Color trend

evolution system
look system

**LACCATO COLOR TREND TIMO LUCIDO,
MAGNOLIA LUX E ROVERE SAHARA.**

GLOSS TIMO COLOR TREND LACQUER,
MAGNOLIA LUX AND ROVERE SAHARA.

**LAQUÉ COLOR TREND TIMO BRILLANT,
MAGNOLIA LUX ET ROVERE SAHARA.**

LACADO BRILLANTE COLOR TREND,
MAGNOLIA LUX Y ROVERE SAHARA.



Color trend

evolution system

look system



↑ LACCATO COLOR TREND OPACO LAVAREDO E CIPRIA OPACO, ROVERE SAHARA.

MATT LAVAREDO AND CIPRIA COLOR TREND LACQUER, ROVERE SAHARA.

LAQUÉ COLOR TREND LAVAREDO ET CIPRIA MAT, ROVERE SAHARA.

LACADO MATE COLOR TREND LAVAREDO Y CIPRIA ROVERE SAHARA.

Bancone con gamba W-leg

Breakfast bar with W-leg
Plan-repas en épi avec piètement W-leg
Barra con pata W-leg

Plus+
Design



↑ → LACCATO COLOR TREND OPACO GRIGIO DAYTONA E GINEPRO.

MATT GRIGIO DAYTONA AND GINEPRO COLOR TREND LACQUER, ROVERE SAHARA.

LAQUÉ COLOR TREND GRIGIO DAYTONA ET GINEPRO MAT, ROVERE SAHARA.

LACADO MATE COLOR TREND GRIGIO DAYTONA Y GINEPRO ROVERE SAHARA.



Karma

look system

ROVERE CORTECCIA, HPL GRAFITE BROWN E PET GRIGIO FUMO OPACO.
ROVERE CORTECCIA, HPL GRAFITE BROWN AND PET GRIGIO FUMO MATT.
ROVERE CORTECCIA, HPL GRAFITE BROWN ET PET GRIGIO FUMO MAT.
ROVERE CORTECCIA, HPL GRAFITE BROWN Y PET GRIGIO FUMO MATE.



Karma

look system



PET BIANCO ASSOLUTO OPACO, FENIX NERO INGO E BIANCO K05. ELEMENTI A GIORNO LACCATO CURCUMA OPACO.

PET BIANCO ASSOLUTO MATT, FENIX NERO INGO AND BIANCO K05. SHELVING UNIT MATT CURCUMA LAQUER.

Joy System

Un pratico sistema per attrezzare lo schienale.

A practical way to fit out splashbacks.

Un système pratique pour aménager la crédence.

Un práctico sistema para equipar la trasera.

**Plus+
Design**



PET BIANCO ASSOLUTO MAT, FENIX NERO INGO ET BIANCO K05. ÉLÉMENTS OUVERTS LAQUÉ CURCUMA MAT.

PET BIANCO ASSOLUTO MATE, FENIX NERO INGO Y BIANCO K5. ELEMENTOS ABIERTOS MATT CURCUMA LAQUER.

Tavolo estraibile

Pullout table
Table extractible
Mesa extraíble

**Plus+
Design**



Infinity

look system

TERMO STRUTTURATO ROVERE CUMINO, MATERICO GRANIGLIA LIMO, PET GINSENG, FENIX® NERO INGO.

THERMO-STRUCTURED ROVERE CUMINO, GRANIGLIA LIMO TEXTURE, GINSENG PET, NERO INGO FENIX®.

THERMOSTRUCTURÉ ROVERE CUMINO, TEXTURÉ GRANIGLIA LIMO, PET GINSENG, FENIX® NERO INGO.

TERMOESTRUCTURADO ROVERE CUMINO, MATÉRICO GRANIGLIA LIMO, PET GINSENG, FENIX® NERO INGO.



PET BEIGE SETA OPACO E ROVERE ANICE

MATTE BEIGE SETA PET - ROVERE ANICE

PET BEIGE SETA MAT - ROVERE ANICE

PET BEIGE SETA MATE - ROVERE ANICE



↑ **ROVERE NATURA, CEMENTO VISONE E PET CACHEMERE OPACO, BOISERIE COMBO LINE_** ROVERE NATURA, CEMENTO VISONE AND MATT CACHEMERE PET, COMBO LINE WALL PANELLING_ ROVERE NATURA, CEMENTO VISONE ET PET CACHEMERE MAT, HABILLAGE MURAL COMBO LINE_ ROVERE NATURA, CEMENTO VISONE Y PET CACHEMERE MATE, BOISERIE COMBO LINE.



Piano snack con cambio di inclinazione

The angled breakfast table.
Plan snack avec changement d'inclinaison.
Barra de comidas rápidas con cambio de inclinación.

Plus+ Design

Alevé

look system



**TERMO STRUTTURATO ROVERE SESAMO,
LACCATO LUCIDO NEVE UV E LACCATO
LUCIDO ARDESIA UV .**

THERMO-STRUCTURED, ROVERE SESAMO,
GLOSS NEVE UV LACQUER AND GLOSS
ARDESIA UV LACQUER.

THERMOSTRUCTURÉ ROVERE SESAMO,
LAQUÉ BRILLANT NEVE UV ET LAQUÉ
BRILLANT ARDESIA UV.

TERMOESTRUCTURADO ROVERE SESAMO,
LACADO BRILLO NEVE UV Y LACADO
BRILLO ARDESIA UV.

Nuovo bordo anta tono su tono

New tone on tone door edgband.
Nouveau bord porte ton sur ton.
nuevo borde puerta tono sobre tono.

**Plus+
Design**



City

look system

TERMO STRUTTURATO ROVERE LIQUIRIZIA E PET BEIGE OPACO.
THERMO-STRUCTURAEED ROVERE LIQUIRIZIA AND MATTE BEIGE PET.
THERMOSTRUCTURÉ ROVERE LIQUIRIZIA ET PET BEIGE MAT.
TERMOESTRUCTURADO ROVERE LIQUIRIZIA Y PET BEIGE MATE.



Living

day solution

ROVERE DARK E MENSOLE IN METALLO LACCATO NERO.
ROVERE DARK AND SHELVES IN NERO LACQUERED METAL.
ROVERE DARK ET ÉTAGÈRES EN MÉTAL LAQUÉ NERO.
ROVERE DARK Y ESTANTES DE METAL LACADO NERO.



Living

day solution

↓ **ROVERE CORTECCIA, HPL GRAFITE BROWN VETRINE ANTE TELAIO TITANO E VETRO CANNETTATO.**

ROVERE MIELE AND HPL GRAFITE BROWN LIVING ROOM FURNITURE WITH "CANNETTATO" GLASS. DISPLAY UNIT DOORS WITH TITANIO FINISH FRAMES.

ROVERE CORTECCIA ET HPL GRAFITE BROWN.

PORTES VITRÉES AVEC CADRE TITANIO ET VERRE "CANNETTATO".

ROVERE CORTECCIA, HPL GRAFITE BROWN Y VITRINAS

CON PUERTAS ENMARCADAS TITANO Y CRISTAL "CANNETTATO".



↑ **LACCATO TIMO LUCIDO E ROVERE SAHARA.**

MAGNOLIA LUX AND ROVERE SAHARA.

MAGNOLIA LUX ET ROVERE SAHARA.

MAGNOLIA LUX Y ROVERE SAHARA.



PET GRAU OPACO E ROVERE NATURA.
 MATT GRAU PET AND ROVERE NATURA.
 MAT GRAU BRILLANT ET ROVERE NATURA.
 PET GRAU MATE Y ROVERE NATURA.

↓ PALO ALTO LIBRERIA IN METALLO CON RIPIANI ROVERE. BASE SOPESA LACCATO NERO.
 PALO ALTO METAL BOOKCASE WITH OAK SHELVES.
 BLACK LACQUERED WALL-HUNG BASE UNIT.

PALO ALTO RAYONNAGE EN MÉTAL AVEC TABLETTES EN CHÊNE. ÉLÉMENT BAS SUSPENDU LAQUÉ NOIR.
 PALO ALTO LIBRERÍA DE METAL CON ESTANTES DE ROBLE.
 MUEBLE BAJO SUSPENDIDO LACADO EN NEGRO.



→ MADIA LACCATO VERDE MALGA OPACO. BASAMENTO IN FINITURA PELTRO.
 SIDEBORD IN MATT VERDE MALGA LACQUER. PELTRO FINISHED BASE.
 BAHUT FINITION LAQUÉ VERDE MALGA. PIÈTEMENT FINITION PELTRO.
 ALACENA EN LACADO VERDE MALGA MATE. BASE EN ACABADO PELTRO.



← ROVERE SAHARA E FINITURE LACCATO COLOR TREND FROST OPACO.

ROVERE SAHARA AND MATT FROST COLOR TREND LACQUER.
 ROVERE SAHARA ET FINITIONS EN LAQUÉ COLOR TREND FROST MAT.
 ROVERE SAHARA Y ACABADO LACADO MATE COLOR TREND FROST.



Newport

classic glam

ROVERE BARRIQUE E LACCATO POMICE OPACO.
ROVERE BARRIQUE AND MATT POMICE LACQUER.
ROVERE BARRIQUE ET LAQUÉ POMICE MAT.
ROVERE BARRIQUE Y LACADO POMICE MATE.



Newport

classic glam

ROVERE AVENA E LACCATO BIANCO ICE.

TOP IN PIETRA NEOLITH® PIETRA DI LUNA.

AVENA ASHWOOD AND BIANCO ICE LACQUER.

PIETRA DI LUNA NEOLITH® STONE WORKTOP.

PLAQUÉ FRÊNE FINITION AVENA ET LAQUÉ BIANCO ICE.

PLAN DE TRAVAIL PIERRE NEOLITH® PIETRA DI LUNA.

MADERA DE FRESNO AVENA Y LACADO BIANCO ICE.

ENCIMERA PIEDRA NEOLITH® PIETRA DI LUNA.

**Plus+
Design**

Elementi Combo Line

Combo Line open elements.
Éléments Combo Line.
Elementos Combo Line.



BASE UNITS WITH FRAMED DOORS IN BEIGE ANGORA ASH. WORKTOP AND SPLASHBACK IN IMPERIAL CAMEL QUARTZ. HOOD UNITS IN COLOR TREND METAL LUX LACQUER. GLAZED-DOOR WALL UNITS IN BEIGE ANGORA ASH_ ÉLÉMENTS BAS AVEC PORTE À CADRE EN FRÊNE COLORIS BEIGE ANGORA. PLAN DE TRAVAIL ET CRÉDENCE EN QUARTZ IMPERIAL CAMEL. MODULES HOTTE LAQUÉS COLOR TREND METAL LUX. ÉLÉMENTS HAUTS VITRÉS EN FRÊNE COLORIS BEIGE ANGORA_ MUEBLES BAJOS CON PUERTA ENMARCADA EN FRASSINO BEIGE ANGORA. ENCIMERA Y TRASERA DE CUARZO IMPERIAL CAMEL. MÓDULOS CON CAMPANA CON ACABADO LACADO COLOR TREND METAL LUX. COLGANTES CON PUERTA DE CRISTAL EN FRESNO BEIGE ANGORA.



BASI CON ANTA A TELAIO IN FRASSINO BEIGE ANGORA. PIANO E SCHIENALE IN QUARZO IMPERIAL CAMEL. MODULI CAPPA IN LACCATO COLOR TREND METAL LUX. PENSILI A VETRO IN FRASSINO BEIGE ANGORA.



↓ **FRASSINO BEIGE ANGORA. LACCATO FROST. HPL ARGILLA. MANIGLIA STRIP.**
 BEIGE ANGORA ASH. FROST LACQUERED. HPL ARGILLA. STRIP HANDLE.
 BOIS DE FRÊNE BEIGE ANGORA. LAQUÉ FROST. HPL ARGILLA. POIGNÉE STRIP.
 PLAQUÉ FRÊNE FINITION BEIGE ANGORA. LACADO FROST. HPL ARGILLA.
 MADERA STRIP.

Tosca
 classic glam



↑ **FRASSINO GRIGIO PERNICE, LACCATO LAVA**
E HPL CALACATTA_ GRIGIO PERNICE ASH, LAVA
 LACQUER AND CALACATTA HPL_FRÊNE COLORIS
 GRIGIO PERNICE, LAQUÉ LAVA ET HPL CALACATTA_
 FRASSINO GRIGIO PERNICE, LACADO LAVA
 Y HPL CALACATTA.

Elementi a giorno con
 struttura in metallo
 finitura Antracite e
 schienali in frassino
 opaco decapè Beige
 Angora.

Éléments ouverts avec
 structure en métal
 finition anthracite et
 fonds en frêne cérusé
 Beige Angora mat.

Open shelving units
 with an Antracite finish
 metal structure and back
 panels in matt Beige
 Angora limed ash.

Módulos abiertos con
 estructura de metal
 acabado en Antracita y
 traseras de fresno mate
 decapado Beige Angora.

**Plus+
 Design**



York
classic glam

ANTA DOGATA IN ROVERE NORDIC E ROVERE BIANCO ARTIC.

SLATTED DOOR IN ROVERE NORDIC AND ROVERE BIANCO ARTIC.

PORTE RAINURÉE EN ROVERE NORDIC ET ROVERE BIANCO ARTIC.

PUERTA CON LISTONES DE ROVERE NORDIC Y ROVERE BIANCO ARTIC.





↓ ANTA DOGATA IN ROVERE CALCE E BIANCO ARTIC.
 SLATTED DOOR IN ROVERE CALCE AND BIANCO ARTIC.
 PORTE RAINURÉE EN ROVERE CALCE ET BIANCO ARTIC.
 PUERTA CON LISTONES DE ROVERE CALCE Y BIANCO ARTIC.

York
 classic glam



↑ ANTA DOGATA IN ROVERE CALCE E ROVERE LAVA E VETRO POMICE_

SLATTED DOOR IN ROVERE CALCE, ROVERE LAVA AND POMICE GLASS _ PORTE RAINURÉE EN FINITION ROVERE CALCE ET ROVERE LAVA ET VERRE POMICE _ PUERTA CON LISTONES EN ROVERE CALCE Y ROVERE LAVAY CRISTAL POMICE.

**Plus+
 Design**

**L'anta della cucina
 si trasforma in una lavagna**

The kitchen door serves as a blackboard
 La porte avec surface tableau noir transforme la porte de cuisine en un tableau.
 La puerta de la cocina se convierte en una pizarra para.



Virginia

classic glam

FINITURA PERLA E FINITURA VERDE SALVIA.
CREDENZA IN FINITURA VERDE SALVIA E PENSIILI IN
VETRO EFFETTO TESSUTO BIANCO.

PERLA AND SALVIA FINISHES. SALVIA FINISH
SIDEBOARD AND WALL UNITS WITH WHITE, FABRIC
EFFECT GLASS DOORS.

FINITION PERLA ET FINITION SALVIA. BUFFET
FINITION SALVIA ET ÉLÉMENTS HAUTS VITRÉS AVEC
VERRE ASPECT TISSU BLANC.

ACABADOS PERLA Y VERDE SALVIA. APARADOR CON
ACABADO VERDE SALVIA Y COLGANTES DE CRISTAL
CON EFECTO TEJIDO BLANCO.

Virginia

classic glam



**ANTA PIENA IN FRASSINO BIANCO.
ELEMENTI GIORNO MOVING WALL SILVER DARK
TAVOLO E SEDIE IMBOTTITE IN FINITURA BIANCO
SEDUTA COLOR GRIGIO.**

PLAIN DOOR IN FRASSINO BIANCO.
MOVING WALL SILVER DARK OPEN SHELVING
BIANCO FINISH TABLE AND CHAIRS, GRIGIO
COLOURED SEAT.

PORTE PLEINE EN BOIS DE FRÊNE BIANCO.
ÉLÉMENTS OUVERTS MOVING WALL EN SILVER
TABLE ET CHAISES REMBOURRÉES FINITION
BIANCO, ASSISE COLORIS GRIGIO.

PUERTA MACIZA EN FRASSINO BIANCO.
ELEMENTOS ABIERTOS MOVING WALL SILVER DARK
MESA Y SILLAS EN ACABADO BIANCO,
ASIENTO COLOR GRIGIO.



Beverly
classic glam

FRASSINO SAVANA, FRASSINO LAVA E HPL OSSIDO.
SAVANA ASH AND LAVA ASH AND HPL OSSIDO.
BOIS DE FRÊNE SAVANA ET LAVA. HPL OSSIDO.
MADERA DE FRESNO SAVANA Y LAVA. HPL OSSIDO.





FRASSINO LAVA, FRASSINO BIANCO E FENIX BEIGE LUXOR.
 LAVA ASH AND BIANCO ASH AND FENIX BEIGE LUXOR.
 BOIS DE FRÊNE LAVA ET BIANCO. FENIX BEIGE LUXOR.
 MADERA DE FRESNO LAVAY BIANCO. FENIX BEIGE LUXOR.

↓ **FRASSINO SAVANA E FRASSINO MALACHITE.**

SAVANA ASH AND MALACHITE ASH.
 BOIS DE FRÊNE SAVANA ET MALACHITE.
 MADERA DE FRESNO SAVANA Y MALACHITE.

Beverly

classic glam



← **FRASSINO SAVANA, FRASSINO BIANCO E FENIX BEIGE ARIZONA**
 SAVANA ASH AND BIANCO ASH AND FENIX BEIGE ARIZONA
 BOIS DE FRÊNE SAVANA ET BIANCO. FENIX BEIGE ARIZONA
 MADERA DE FRESNO SAVANA Y BIANCO. FENIX BEIGE ARIZONA

Dolcevita

classic glam

COMPOSIZIONE IN LACCATO AVORIO OPACO, COLONNE IN LACCATO ZINCO OPACO. TOP IN NEOLITH® CALACATTA SILK. PIANO SNACK E GAMBONE SAGOMATO IN LACCATO ZINCO OPACO. MANIGLIE IN FINITURA ARGENTO INGLESE.

COMPOSITION IN MATTE AVORIO LACQUER, TALL UNITS IN MATTE ZINCO LACQUER. TOP IN CALACATTA SILK NEOLITH®. SNACK TOP AND SHAPED LEG IN MATTE ZINCO LACQUER.

COMPOSITION EN LAQUÉ AVORIO MAT, ARMOIRES EN LAQUÉ ZINCO MAT. PLAN DE TRAVAIL EN NEOLITH® CALACATTA SILK. PLAN SNACK ET PIED GALBÉ EN LAQUÉ ZINCO MAT. POIGNÉES FINITION ARGENTO INGLESE.

COMPOSICIÓN LACADA EN AVORIO MATE, COLUMNAS LACADAS EN ZINCO MATE. ENCIMERA EN NEOLITH® CALACATTA SILK. BARRA DE COMIDAS RÁPIDAS Y PATA CON FORMA LACADAS EN ZINCO MATE. TIRADORES CON ACABADO ARGENTO INGLESE.





POSITION EN LAQUE CENERE MATE ET COLONNES EN LAQUE CARBON MATE. PORTES, CADRES ET CÔTÉS AVEC FIL D'ARGENT VIEILLI. PLAN DE TRAVAIL EN NEOLITH® CALACATTA SILK. HOTTE EN LAQUE CARBONE MAT. POIGNÉES EN FINITION ARGENT ANGLAIS.

COMPOSICIÓN EN LACADO CENERE MATE Y COLUMNAS EN LACADO CARBON MATE. PUERTAS, MARCOS Y LATERALES CON HILO DE PLATA ENVEJECIDO. ENCIMERA DE NEOLITH® CALACATTA SILK. CAMPANA EN LACADO CARBON MATE. TIRADORES EN ACABADO PLATEADO INGLÉS.

Dolcevita

classic glam

COMPOSIZIONE IN LACCATO CENERE OPACO E COLONNE IN LACCATO CARBON OPACO. ANTE, CORNICI E FIANCHI CON ANTICATURA FILO ARGENTO. TOP IN NEOLITH® CALACATTA SILK. CAPP A IN LACCATO CARBON OPACO. MANIGLIE IN FINITURA ARGENTO INGLESE.

COMPOSITION IN MATTE CENERE LACQUER AND TALLUNITS IN MATTE SEPIA LACQUER. DOORS, SURROUNDS AND SIDES WITH ARGENTO LINE AGEING. TOP IN CALACATTA SILK NEOLITH®. HOOD IN MATTE CARBON LACQUER. HANDLES IN ARGENTO INGLESE FINISH.



Bolgheri

classic glam



↓ **FINITURA BURRO.**
BURRO FINISH CUVEE.
FINITION BURRO.
ACABADOS BURRO.

↑ **BASI E PENSILI IN FINITURA BIANCO COTONE.**
MANIGLIA MX0A.

BASE AND WALL UNITS WITH A BIANCO COTONE
FINISH. MX0A HANDLE.

ÉLÉMENTS BAS ET HAUTS FINITION BIANCO CO-
TONE. POIGNÉE MX0A.

MUEBLES BAJOS Y COLGANTES ACABADOS EN
BIANCO COTONE. TIRADOR MX0A.





NEW

La nuova maniglia godronata si aggiunge al sistema aperture Stosa.

The new knurled handle is an addition to the Stosa range of opening systems.

La nouvelle poignée godronnée vient s'ajouter au système d'ouvertures Stosa.

el nuevo tirador godronata se suma al sistema de aperturas Stosa.

Maniglia godronata
knurled handle

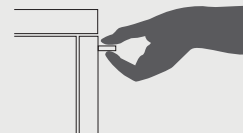

MT

MANIGLIE IN TESTA

Handles at the top
Poignées s'installant sur le chant haut
Tiradores en la parte de arriba



Onda

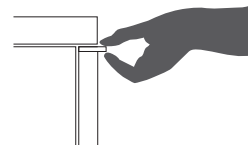

Diamond

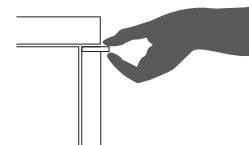

MI

MANIGLIE INTEGRATE

Integrated handles
Poignées incorporées
Tiradores integrados

Le maniglie integrate sono disponibili per i modelli di cucine Karma, Tosca e Newport.

Recessed handles are available for the Karma, Tosca and Newport kitchens.

Les poignées intégrées existent pour les modèles de cuisines Karma, Tosca et Newport.

Los tiradores integrados están disponibles para los modelos de cocinas Karma, Tosca y Newport.

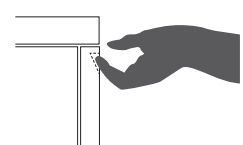

Sistema aperture

Opening system. Systèmes d'ouverture. Sistema de aperturas.

M

MANIGLIE Handles
Poignées / Tiradores



Balance

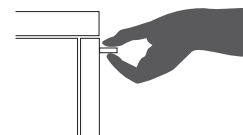

Brooklyn

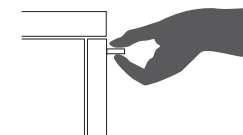

Blade

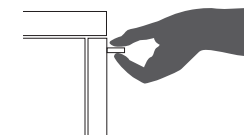

POCKET (a Incasso)

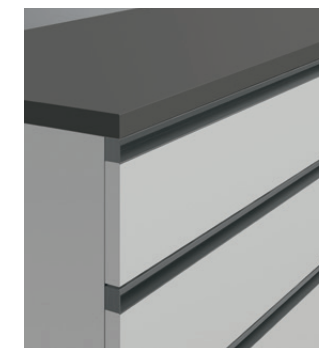
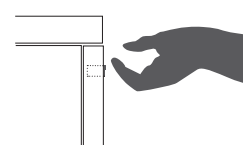

Linear

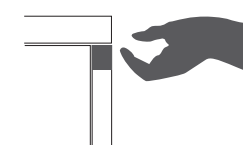

Grip

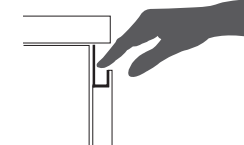

GOLA PIATTA flat groove / gorge plate / ranura plana

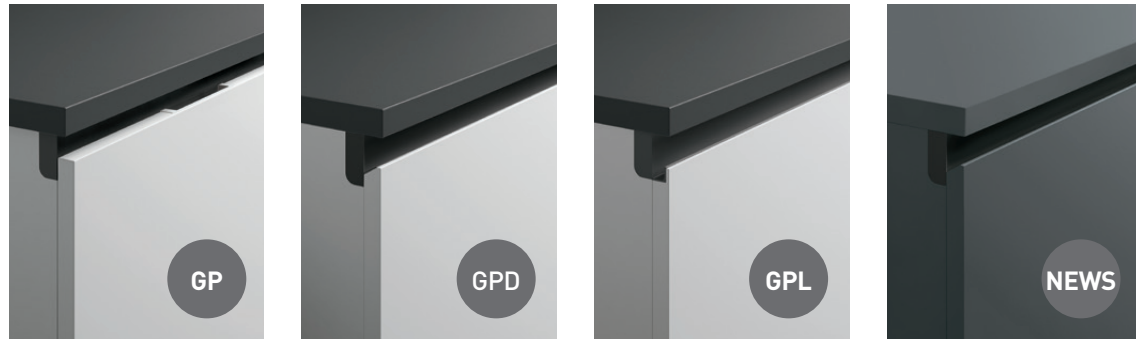

Gola piatta con tasca
Flat groove with pocket
Gorge plate avec encoche
Ranura plana con bolsillo

Gola maniglia con "Diagonal"
"Diagonal" handle grip
Gorge avec prise de main "Diagonal"
Ranura "Diagonal"

Gola con presa maniglia "L"
Flat "L" handle grip
Gorge avec prise de main en "L"
Ranura en "L"

Presca Inclinata 40°
40° handle grip
Prise de main inclinée 40°
Borde de agarre inclinado 40°

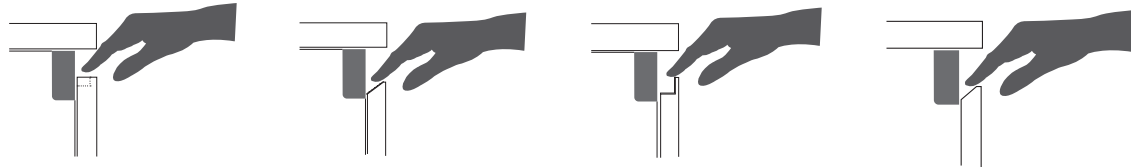

alluminio verniciato _ painted aluminium _ aluminium verni _ aluminio pintado



Per disponibilità colori e tipo di gole nei modelli Classic Glam fare riferimento al listino prezzi.
Refer to the price lists for availability of colors and types of grooves in the Classic Glam models.

OPTIONAL - FIANCO FINALE DI SCOCCA PER GOLA

straight carcass side panel for groove / côté caisson de terminaison pour gorge / costado de la estructura para ranura



La gola piatta è disponibile anche nella versione con fianco di scocca senza la sagomatura della gola.

The flat groove is also available paired with a straight carcass side panel without a groove.

La gorge plate est également disponible dans la version avec côté caisson sans le galbage de la gorge.

La ranura plana está disponible también en la versión con el costado de la estructura sin conformado.

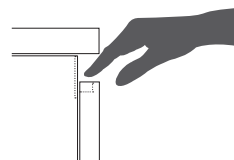

GOLA SCAVATA hollow groove / gorge creusée / ranura hundida



Gola scavata
Hollow groove
Gorge creusée
Ranura hundida

Gola maniglia "Diagonal"
"Diagonal" handle grip
Gorge avec prise de main "Diagonal"
Ranura "Diagonal"

Presca maniglia "L"
"L" handle grip
Gorge avec prise de main en "L"
Ranura en "L"

Presca Inclinata 40°
40° handle grip
Prise de main inclinée 40°
Borde de agarre inclinado 40°



alluminio verniciato _ painted aluminium _ aluminium verni _ aluminio pintado

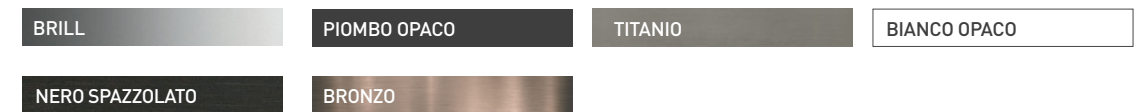

alluminio laccato _ lacquered aluminium _ aluminium laqué _ aluminio lacado



OPTIONAL - FIANCO FINALE DI SCOCCA PER GOLA

straight carcass side panel for groove / côté caisson de terminaison pour gorge / costado de la estructura para ranura



La gola scavata è disponibile anche nella versione con fianco di scocca senza la sagomatura della gola.

The hollow groove is also available paired with a straight carcass side panel without a groove.

La gorge creusée est également disponible dans la version avec côté caisson sans le galbage de la gorge.

La ranura hundida está disponible también en la versión con el costado de la estructura sin conformado.

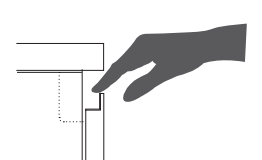

Design al Top

Neolith® Pietra Sinterizzata: Senti la bellezza e durabilità della tua cucina

SINTERED STONE: FEEL THE BEAUTY AND DURABILITY OF YOUR KITCHEN. Thanks to sintering technology consisting in subjecting 100% natural materials to very high pressures and temperatures, NEOLITH® stands for research and innovation.

To this aim, NEOLITH® creates a surface that is very resistant to scratches, to high temperatures, to chemical agents and to UV rays as well as repelling stains and having an absorption capacity that is practically equal to zero because it boasts almost 0% porosity. NEOLITH® uses HYDRO-NDD 2.0, a water-based decorative technique that drastically reduces harmful emissions into the environment which are typical of traditional printing methods.

PIERRE SINTÉRISÉE: SENTEZ LA BEAUTÉ ET LA DURABILITÉ DE VOTRE CUISINE. NEOLITH® veut dire recherche et innovation grâce à la Technologie de Sinterisation qui consiste à soumettre les matières premières 100% naturelles à une pression et à des températures très élevées. C'est ainsi que NEOLITH® crée une surface qui a une extrême résistance aux rayures, aux hautes températures, aux agents chimiques et aux rayons UV et qui a également la capacité de repousser les taches et de disposer d'un degré d'absorption pratiquement nul grâce à sa porosité à peu près égale à 0%. NEOLITH® utilise HYDRO-NDD 2.0, une technique de décoration à base d'eau qui réduit énormément la dispersion dans la pièce d'émissions typiques des méthodes d'impression traditionnelles.

PIEDRA SINTERIZADA: SIEN TA BELLEZA Y DURABILIDAD DE SU COCINA. NEOLITH® es investigación e innovación gracias a la tecnología de sinterización que consiste en someter las materias primas 100% naturales a presiones y temperaturas muy altas. A tal propósito, NEOLITH® crea una superficie con suma resistencia a rayado, altas temperaturas, agentes químicos y radiaciones UV, además de poder repeler las manchas y disponer de un grado de absorción prácticamente nulo, gracias a su casi 0% de porosidad. NEOLITH® utiliza HYDRO-NDD 2.0, una técnica de decoración basada en el agua que reduce en gran medida la dispersión en el entorno de las emisiones, típicas de los métodos de impresión tradicionales.

JUST WHITE SILK

NERO SATIN

PIETRA DI LUNA SILK

CEMENT SATIN

BARRO SATIN

PIETRA DI PIOMBO SILK

WULUNG

SHILING

BASALT BLACK SATIN

CALACATTA SILK

CALATORAO SILK

ZAHA STONE SILK

NEW YORK SILK

METROPOLITAN

NERO ZIMBABWE

ABU DHABI

IRON MOSS

CEPPO DI GRE

RETROSTONE

IRON GREY



NEOLITH®
per
STOSA
CUCINE



NEOLITH® è ricerca e innovazione grazie alla Tecnologia di Sinterizzazione che consiste nel sottoporre le materie prime naturali al 100% a pressione e temperature elevatissime. Con questo proposito, NEOLITH® crea una superficie dall'estrema resistenza a graffi, alte temperature, agenti chimici e raggi UV, oltre ad avere la capacità di respingere le macchie e disporre di un grado di assorbimento praticamente nullo, grazie alla sua porosità quasi dello 0%. NEOLITH® utilizza HYDRO-NDD 2.0 una tecnica di decorazione basata sull'acqua che riduce enormemente la dispersione nell'ambiente di emissioni, tipiche dei metodi di stampa tradizionali.



La lastra di Neolith® è composta fino al 52% di materiale riciclabile.

Neolith® slabs are composed of up to 52% recyclable materials

La plaque de Neolith® se compose jusqu'à 52% de matériau recyclable.

La lámina de Neolith® está compuesta hasta un 52% de material reciclable.



100% Naturale. Senza resina e sostanze nocive all'ambiente.

100% Natural, sin resinas ni sustancias perjudiciales para el medio ambiente.

100% Naturel. Sans résine ni substance nocive pour l'environnement.

100% Natural, sin resinas ni sustancias perjudiciales para el medio ambiente.

Design al Top

TOP CUCINA: QUALE SCEGLIERE?
 ECCO LE PROPOSTE DI STOSA.
 WHICH KITCHEN WORKTOP SHOULD YOU CHOOSE? CHECK OUR STOSA'S OPTION.
 PLAN DE TRAVAIL : LEQUEL CHOISIR ?
 VOICI LES PROPOSITIONS DE STOSA.
 ENCIMERA DE COCINA: ¿CUÁL ELEGIR? AQUÍ ESTÁN LAS PROPUESTAS DE STOSA.

HPL®



Il laminato stratificato HPL è un materiale dalle elevate potenzialità funzionali ed estetiche per i top: impermeabile all'acqua e agli oli, resistente al vapore e alle alte temperature, facile da pulire. Permette la lavorazione del bordo a 45° e la realizzazione di lavabi nella stessa finitura del top o con il fondo in acciaio.

HPL is a material with high functional and aesthetic potential for tops: it's impermeable to water and oils, resistant to steam and high temperatures and easy to clean. The edge can be bevelled at 45° and sinks can be made from this material in the same finish as tops or with a steel base.

Le stratifié HPL est un matériau avec de hautes qualités fonctionnelles et esthétiques pour la réalisation des plans de travail: imperméable à l'eau et à l'huile, résistant à la vapeur et aux hautes températures, facile à nettoyer. Il permet de réaliser des chants à 45° et des cuves d'évier dans la même finition que le plan de travail ou bien avec le fond en acier.

El laminado estratificado HPL es un material con un alto potencial funcional y estético para la encimera: impermeable al agua y a los aceites, resistente al vapor y a altas temperaturas, fácil de limpiar. Permite el procesamiento del borde de 45° y la creación de fregaderos en el mismo acabado de la encimera o con el fondo de acero.



Laminato



Il laminato è un materiale che offre un'ampia gamma di colori e finiture per il top della cucina. Versatile ed eclettico, può riprodurre l'estetica di un grande numero di materiali, come il legno e la pietra naturale. Si pulisce facilmente con un panno umido imbevuto di acqua e sapone, ma è necessario asciugare la superficie.

Laminated is a material that offers a broad range of colours and finishes for kitchen worktops. Versatile and eclectic, it can imitate the look of a great number of materials, like wood and natural stone. It can be cleaned easily using a damp cloth soaked in water and soap, but it is important to dry the surface.

Le stratifié est un matériau qui offre une vaste gamme de couleurs et de finitions pour le plan de travail de la cuisine. Polyvalent et éclectique, il peut reproduire l'aspect d'un très grand nombre de matériaux comme le bois ou la pierre naturelle. Il se nettoie facilement avec un chiffon humide et du savon, mais il n'est pas nécessaire d'essuyer la surface.

El laminado es un material que ofrece una extensa gama de colores y acabados para la encimera de la cocina. Versátil y ecléctico, puede reproducir la estética de una gran cantidad de materiales, como la madera y la piedra natural. Es fácil de limpiar con un paño húmedo empapado en agua y jabón, pero es necesario secar la superficie.

60 60 finish options
 60 finitions au choix
varianti di finiture



Fenix®

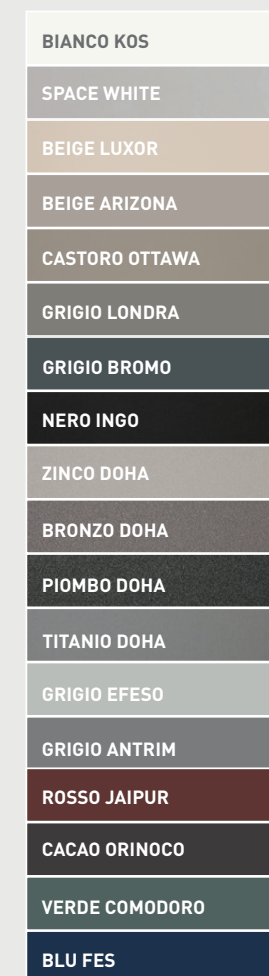

L'innovativo materiale FENIX NTM® versatile in cucina per le sue caratteristiche tecniche non richiede una manutenzione particolare: è sufficiente un panno umido, con acqua calda o detersivi delicati.

The innovative FENIX NTM® material is versatile in the kitchen thanks to its technical characteristics. It does not require special maintenance: a wet cloth moistened with hot water or delicate detergents is sufficient.

L'innovant matériau FENIX NTM®, très polyvalent dans la cuisine de par ses caractéristiques techniques, ne nécessite aucun entretien particulier: il suffit d'utiliser un chiffon humide, de l'eau chaude ou un produit de nettoyage délicat.

El novedoso material FENIX NTM® versátil en la cocina debido a sus características técnicas no requiere mantenimiento especial: un paño húmedo es suficiente, con agua tibia o detergentes delicados.



icone icons icônes iconos



Design al Top

Pietre naturali



SEQUOIA BROWN
GREY STONE
VIA LATTEA
CAPPUCCINO
SILVER GREY
BLACK FANTASY
COPPER DUNE
BROWN ANTIQUE
BROWN CHOCOLATE
PETIT GRANIT

PIETRE NATURALI
Rimangono tra i materiali più pregiati, indiscussamente belli e resistenti, offrono un'incredibile varietà di colori e forme.

NATURAL STONE
Still one of the most precious, undisputedly beautiful and resistant materials, natural stone is available in an incredible variety of colours and forms.

PIERRES NATURELLES
Elles font partie des matériaux de plus haute qualité, elles sont incontestablement belles et résistantes et offrent une incroyable variété de teintes et de formes.

PIEDRAS NATURALES
Permanecen entre los mejores materiales, indudablemente bellos y resistentes, ofreciendo una increíble variedad de colores y formas.

**+30
di 30
varianti**

+ than 30 options.
+ de 30 variantes
+ de 30 variantes

Dekton



SIROCCO
SIRIUS
FOSSIL
KELYA
TRILUM
LAOS
LUNAR
ZENITH

DEKTON realizzato con materie prime di ultima generazione, consente di realizzare installazioni con pezzi di grande formato, senza giunzioni, senza limiti di bellezza.

DEKTON is made of sophisticated, latest-generation raw materials that can be supplied in very large, seamless slabs that set no limits to beauty.

DEKTON Ce matériau est fabriqué avec des matières premières de dernière génération et permet de réaliser des plans de travail de grand format sans aucune jonction, au profit de la beauté.

DEKTON hecho con materias primas de última generación, permite realizar instalaciones con piezas de gran tamaño, sin juntas y sin poner límites a la belleza.



Quarzo



PORTLAND GREY ST 630
CLOUDY BEIGE ST 620
CLOUDY WHITE ST 615
ICEBERG WHITE ST 300
CLOUDY BLACK ST 600
DARK GREY ST 515
ABSOLUTE WHITE ST 400
CLOUDY BROWN ST 605
IMPERIAL BROWN ST 950
IMPERIAL WHITE ST 955
IMPERIAL CARAMEL ST 930
TOP CRYSTAL BLACK ST 705
NIGHT BLACK ST305
SUGHERO
MERCURY
MAGNOLIA
TEMPEL

Il quarzo è un materiale estremamente durevole e resistente. I piani cucina in quarzo, che richiedono poca manutenzione, non assorbono umidità o cibi e si puliscono facilmente con un panno umido, senza agenti chimici o protettivi.

Quartz is an extremely durable and resistant material. Quartz tops for the kitchen because it requires very little maintenance, does not absorb moisture or food and is easy to clean with a wet cloth, without having to use chemical or protective agents.

Le quartz est un matériau extrêmement durable et résistant. Les plans de travail en quartz se distinguent davantage car ils nécessitent peu d'entretien, ils n'absorbent ni humidité ni aliments quels qu'ils soient et se nettoient facilement avec un chiffon humide sans besoin d'utiliser de produits chimiques ou protecteurs.

El cuarzo es un material extremadamente duradero y resistente. Las encimeras de cuarzo, que requieren poco mantenimiento, no absorben humedad ni alimentos y se pueden limpiar fácilmente con un paño húmedo, sin agentes químicos o protectores.



icone icons icônes iconos



Resistenza al calore
Resistant to heat
Résistance à la chaleur
Resistente al calor



Resistenza all'acqua, all'umidità e al vapore
Resistant to water, moisture and vapour
Résistance à l'eau, à l'humidité et à la vapeur
Resistente al agua, a la humedad y a los vapores



Resistenza alla fessurazione
Resistant to cracking
Résistance aux fissures
Resistente al agrietamiento



Resistenza agli urti
Impact resistant
Résistance aux chocs
Resistente a los golpes



Facilità di pulizia
Easy to clean
Nettoyage aisé
Fácil de limpiar



Resistenza ai prodotti chimici domestici
Resistant to chemical household products
Résistance aux produits chimiques domestiques
Resistente a productos químicos domésticos



Adatto al contatto con gli alimenti
Food safe
Aptitude au contact alimentaire
Idóneo al contacto con alimentos



Anti-impronta
Anti-fingerprint
Anti-traces de doigts
Anti-huella



Morbido al tatto
Soft-touch
Doux au toucher
Suave al tacto



Antimuffa
Mould-proof
Anti-moisissures
Resistente al moho



Stabilità cromatica alla luce
Colours are stable to light
Stabilité des couleurs à la lumière
Estabilidad cromática a la luz



Resistente ai graffi
Resistant to scratching
Résistant aux rayures
Resistente al rayado

Inside design

STOSA IL DESIGN DENTRO E FUORI LA CUCINA.
 STOSA SEES TO THE DESIGN INSIDE AND OUTSIDE THE KITCHEN.
 STOSA SOIGNE LE DESIGN TANT À L'INTÉRIEUR QU'À L'EXTÉRIEUR DE LA CUISINE.
 STOSA, EL DISEÑO DENTRO Y FUERA DE LA COCINA.



BIANCO

STONE

TITANIO

Sponde di serie per cassetti e cestoni. Standard sides for drawers and drawer boxes. Côtés standard pour tiroirs et casseroiliers. Bordes de serie para cajones y gavetas.



BIANCO



leather-effect aspect cuir efecto piel
 STONE effetto pelle



leather-effect aspect cuir efecto piel
 TITANIO effetto pelle

Fondi di serie per cassetti e cestoni. Standard bottoms for drawers and drawer boxes. Fonds standard pour tiroirs et casseroiliers. Fondos de serie para cajones y gavetas.

CASSETTI E CESTONI

DRAWERS AND DRAWER BOXES
 TIROIRS ET CASSEROLIERS
 CAJONES Y GAVETAS

Le finiture interne di cassetti e cestoni sono coordinate cromaticamente tra di loro per un'estetica perfetta. Scopri in queste pagine il "total look" ideale per la tua cucina.

The finishes inside drawers, drawer boxes and tall units are colour-coordinated for an absolutely perfect look. Find the ideal total look for your kitchen on these pages.

Les finitions intérieures des tiroirs et des casseroiliers sont assorties au niveau des coloris pour un effet esthétique parfait. Découvrez dans ces pages « le total look » idéal pour votre cuisine.

El acabado interior de los cajones y gavetas ofrece un acertado juego cromático y una estética perfecta. Descubre en estas páginas "el total look" ideal para tu cocina.



Sponde optional per cassetti e cestoni. Optional sides for drawers and drawer boxes. Côtés optionnels pour tiroirs et casseroiliers. Bordes opcionales para cajones y cestos.

TITANIO leather-effect effetto pelle aspect cuir efecto piel

STONE leather-effect effetto pelle aspect cuir efecto piel

Stosa ti permette di personalizzare gli interni con una serie esclusiva di abbinamenti cromatici.

With Stosa you can personalise your drawer interiors with an exclusive series of colour pairings.

Stosa vous permet de personnaliser l'intérieur des meubles en offrant une série de combinaisons de couleurs uniques.

Stosa te permite personalizar el interior con una variedad exclusiva de combinaciones de colores.

Inside design

Sponde Titanio / Titanio sides /
côtés Titanio / Titanio bordes



Cover Titanio effetto
pelle e sponda finitura
Titanio.

Titanio leather-effect
cover and
Titanio-finished side.

Insert finition Titanio
aspect cuir et côté
finition Titanio.

Revestimiento efecto
piel Titanio y borde en
acabado Titanio.

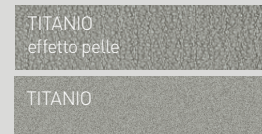

Sponde Stone / Stone sides /
côtés Stone / Stone bordes



Cover Stone effetto pelle
e sponda in finitura
Stone.

Leather-effect Stone
cover and
Stone-finished side.

Insert finition Stone
aspect cuir et côté
finition Stone.

Revestimiento efecto
piel Stone y borde en
acabado Stone.

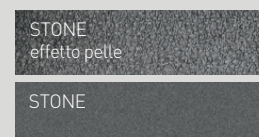

IL DESIGN DENTRO E FUORI LA CUCINA.
STOSA TI PERMETTE DI PERSONALIZZARE
GLI INTERNI DEI CASSETTI E CESTONI CON UNA SERIE ECLUSIVA
DI ACCESSORI PER ORGANIZZARE AL MEGLIO IL TUO SPAZIO.



DESIGN IN AND OUTSIDE THE KITCHEN. STOSA LETS YOU CUSTOMISE THE INTERIORS OF STANDARD
AND DEEP DRAWERS WITH AN EXCLUSIVE SERIES OF ACCESSORIES FOR OPTIMISING SPACE.

LE DESIGN DANS L'ESPACE CUISINE ET AU-DELÀ. STOSA VOUS PERMET DE PERSONNALISER
L'INTÉRIEUR DES TIROIRS ET DES CASSEROLIERS AVEC UNE GAMME EXCLUSIVE D'ACCESSOIRES POUR MIEUX ORGANISER VOTRE ESPACE

DISEÑO DENTRO Y FUERA DE LA COCINA. CON STOSA PUEDES PERSONALIZAR EL EQUIPAMIENTO INTERIOR
DE LOS CAJONES Y CESTOS CON UNA SERIE DE ACCESORIOS EXCLUSIVOS PARA APROVECHAR TUS ESPACIOS AL MÁXIMO.

BASI AD ANGOLO ATTREZZATE

EQUIPPED CORNER BASE UNITS
ÉLÉMENTS BAS D'ANGLE ÉQUIPÉS
MUEBLES BAJOS ANGULARES
EQUIPADOS

In una cucina Stosa gli angoli diventano spazi utili per il contenimento: una vasta gamma di accessori permette di organizzare anche gli interni meno accessibili e di sfruttarli al meglio.

In a Stosa kitchen, corners become useful storage spaces: a wide range of accessories enables organise less accessible internal spaces so that they can be used to the fullest.

Dans une cuisine Stosa, les angles deviennent des espaces utiles pour le rangement : une vaste gamme d'accessoires permet d'organiser également les intérieurs les moins accessibles et de les exploiter de la meilleure manière.

En una cocina Stosa los rincones se convierten en espacios útiles para guardar cosas: una amplia gama de accesorios ayuda a organizar hasta el interior menos accesible y aprovecharlo plenamente.



Base ad angolo con cesti girevoli Freedom.

Corner base unit with Freedom swivel baskets.
Élément bas d'angle avec plateaux pivotants Freedom.

Mueble bajo de esquina con bandejas con cestas giratorias Freedom.

Finitura cesti / Basket finishes

Finition plateaux / Acabado de los cestos

Finitura fondo / Bottom finishes

Finition fond / Acabado del fondo

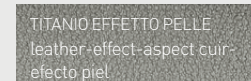
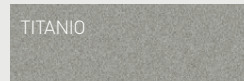
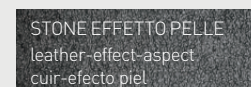

Inside design



Base ad angolo con cesti estraibili con filo metallico.

Corner base unit with metal wire pull-out baskets.

Élément bas d'angle avec paniers extractibles en fil métallique.

Mueble bajo angular con cestos extraíbles de alambre.

Finitura cesti / Basket finishes

Finition paniers / Acabado de las bandejas

Finitura fondo / Bottom finishes

Finition fond / Acabado del fondo

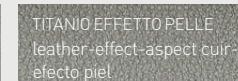
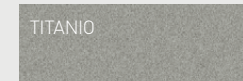
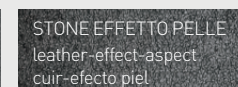
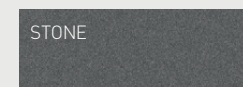

Base ad angolo con gruppo estraibile.

Corner base unit with pull-out storage units.

Éléments bas d'angle avec structure extractible.

Mueble bajo angular con grupo extraíble.

Finitura cesti / Basket finishes

Finition paniers / Acabado de las bandejas

Finitura fondo / Bottom finishes

Finition fond / Acabado del fondo

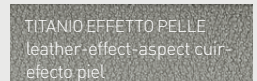
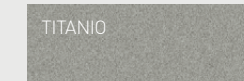
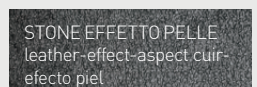
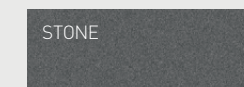

Inside design

inside
Design



Colonna da 15 - 30 cm estraibile
15-30 cm pull-out tall unit
Armoire de 15 - 30 cm coulissante
Columna extraíble de 15-30 cm



Colonna estraibile girevole da 30 cm
30 cm rotating pull-out tall unit
Armoire extractible pivotante de 30 cm
Columna extraíble giratoria de 30



Colonna da 30 cm total view
30 cm total view pull-out
tall unit
Armoire de 30 cm total view
Columna total view de 30 cm



Colonna da 45 - 60 cm estraibile
45-60 cm pull-out tall unit
Armoire de 45-60 cm extractible
Columna extraíble de 45-60 cm



Colonna da 45-60 cm con 5 cesti interni
45-60 cm tall units with 5 interior shelves
Armoire de 45 -60 cm extractible avec 5 paniers intérieurs
Columna de 45 -60 cm extraíble con 5 bandejas



Colonna estraibile da 15-30 cm con sponde in vetro o filo metallico Stone e Titanio e fondi cestelli in nobilitato effetto pelle.

15-30 cm pull-out tall unit with glass or Stone or Titanio metal wire sides and leather-effect melamine drawer bottoms.

Armoire coulissante de 15-30 cm avec côtés en verre ou en fil métallique Stone ou Titanio et fonds des paniers en mélaminé aspect cuir.

Columna extraíble de 15-30 cm con bordes de vidrio o rejilla Stone y Titanio, fondos de los las bandejas de melamina efecto piel.

Finitura cesti / Basket finishes

STONE

TITANIO

Finitura fondo / Bottom finishes

STONE EFFETTO PELLE
leather-effect-aspect cuir -efecto piel

TITANIO EFFETTO PELLE
leather-effect-aspect cuir -efecto piel

Inside design



Portaposate CUISIO profondità 50-60 cm
 CUISIO cutlery tray, 50-60 cm deep
 Range-couverts CUISIO profondeur 50-60 cm
 Cubertero CUISIO profundidad 50-60 cm

ANTRACITE NERO



Organizzatore per cestoni PREMIÈRE
 PREMIÈRE deep drawer insert
 Kit organisateur pour casseroiliers PREMIÈRE
 Organizador para gavetas PREMIÈRE



Portaposate PREMIÈRE
 PREMIÈRE cutlery tray
 Range-couverts PREMIÈRE
 Cubertero PREMIÈRE



Portaposate PVC fino larghezza 120 cm
 PVC cutlery tray, up to 120 cm wide
 Range-couverts en PVC jusqu'à
 une large de 120 cm
 Cubertero PVC hasta 120 cm de de ancho



Portaposate COMBI
 COMBI cutlery tray
 Range-couverts COMBI
 Cubertero COMBI



Sistema Sliding

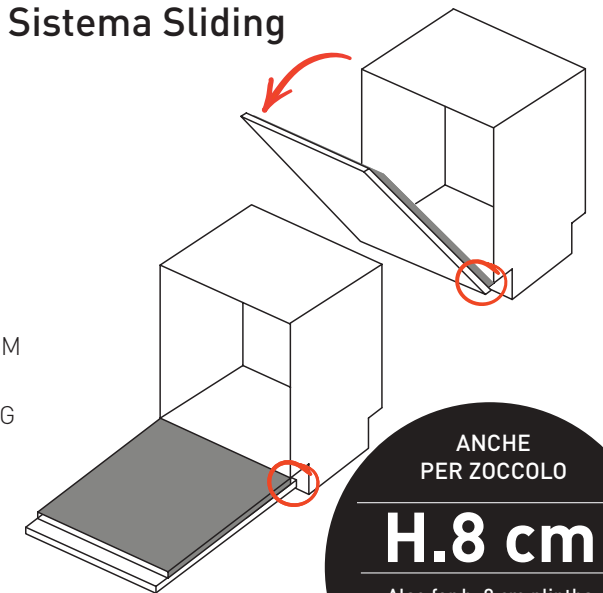

Anta lavastoviglie con SISTEMA SLIDING disponibile anche per zoccolo h. 8 cm.

Dishwasher door with SLIDING-HINGE SYSTEM
 also available for 8-cm high plinths.
 Porte de lave-vaisselle avec SYSTÈME SLIDING
 également valable pour socle h. 8 cm.
 Puerta de lavavajillas con SISTEMA SLIDING
 disponible también para zócalo h. 8 cm.

Scopri tutti materiali e le finiture su stosa.it

Check out all our materials and finishes at stosa.it
 Voir tous les matériaux et toutes les finitions sur stosa.it
 Descubre todos los materiales y acabados en stosa.it

ANCHE
 PER ZOCCOLO

H.8 cm

Also for h. 8 cm plinths
 Également valable
 pour socle h. 8 cm
 También para
 zócalo h.8 cm

Inside design



Multipresa H. max h.33 cm
 Tall power strip max h. 33 cm
 Bloc multiprises escamotable H. max 33 cm
 Toma múltiple H. máx. 33 cm

Sistema di apertura push and pull. 3 prese Schuko e 2 prese USB. Protezione bambini e indicatore Led.
 Concealed pop-up system. Three Schuko sockets and two USB ports. Child protection and LED indicator.
 Système d'ouverture push and pull. 3 prises Schuko et 2 ports USB. Protection enfants et indicateur Led.
 Sistema de apertura push and pull. 3 tomas Schuko y 2 tomas USB. Protección para los niños e indicador Led.



Luci sottopensile al metro
 Midway lighting per metro
 Barre d'éclairage sous-haut au mètre
 Luces bajo colgante por metro



Barra oggettistica luminosa GHIBLI
 Luminous accessory rail GHIBLI
 Barre de crédence lumineuse GHIBLI
 Barra portaobjetos con luz GHIBLI



inside
Design

Attacca e stacca gli accessori dallo schienale magnetico e posizionali dove ti è più comodo.
 Attach and detach accessories from the magnetic back panel and place them where it's most convenient for you.
 Accrochez et décrochez les accessoires de la crédence magnétique et placez-les à l'endroit le plus pratique pour vous.
 Quita y pon los accesorios del panel magnético y colócalos donde te resulte más cómodo.

Finiture / Finishes / Finitions / Acabado

Vetro / Glass / Verre / Cristal

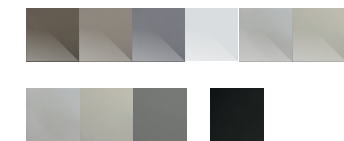

Vetro disponibile a richiesta nei colori RAL.
 On request our glass is also available in RAL colours.
 Verre disponible, sur commande, dans les coloris RAL.
 Cristal disponible bajo pedido en los colores RAL.

Schienali magnetici. Accensione luce gestuale con sensore.
 Magnetic back panels. A motion sensor switches the lights on.
 Crédences magnétiques. Allumage de l'éclairage avec détecteur de mouvement.
 Paneles magnéticos. Encendido de la luz gestual con sensor.

consigli e manutenzione

Prenditi cura della tua cucina

Alcuni consigli utili per mantenere la vostra cucina bella e funzionale nel tempo.

We would like to give you a few useful tips to keep your kitchen beautiful and functional over time.

Voici quelques conseils utiles pour que votre cuisine soit toujours belle et fonctionnelle.
Algunos consejos útiles para mantener tu cocina bella y funcional en el tiempo.



Ripulire con tempestività la cucina, evitare di lasciare essiccare macchie e sporco. Caffè, succo di limone, sale, olio, pomodoro e molti altri prodotti di uso quotidiano danneggiano la cucina.



Per la pulizia di ante e pensili usare un panno morbido inumidito con aggiunta di detersivo neutro. Asciugare subito. Non utilizzare acidi, detersivi con basi forti o solventi e spugne abrasive.

Accendere sempre la cappa ad ogni operazione di cottura. Fumo e vapore possono alla lunga danneggiare la cucina.



Evitare l'utilizzo di pulitori a vapore. Il vapore può far rigonfiare gli elementi della cucina.



Mantenere gli elettrodomestici sempre puliti, ordinati e igienizzati è fondamentale per la salute e per farli durare correttamente più a lungo. È importante consultare l'istruzione dei vari produttori.



Asciugate il piano dove l'acqua può essere caduta incidentalmente. Gocciolamenti, infiltrazioni d'acqua e calcare danneggiano la cucina.



Non appoggiare sui top pentole e utensili roventi per farlo durare di più, nonostante molti materiali hanno buona resistenza al calore.



Evitare di sovraccaricare i cassetti, cestoni e ripiani e distribuire i pesi in maniera uniforme.

Lasciare raffreddare la lavastoviglie alla fine del ciclo di lavaggio. Il vapore che si sprigiona, nel tempo potrebbe danneggiare la cucina.



Per la pulizia dell'acciaio inox usare prodotti specifici, eliminare le macchie ostinate con l'aceto. Non adoperare pagliette in acciaio né altri materiali abrasivi che graffiano.



Advice and maintenance.
Take care of your kitchen.



CURA DEGLI ELETTRODOMESTICI

Taking care of household appliances. Keeping your appliances clean, tidy and sanitised at all times is of paramount importance for your health and to keep them in perfect working order longer. Please consult the appliance's manufacturer's instructions.

Entretien des électroménagers. Il est fondamental de garder les électroménagers toujours propres, ordonnés et désinfectés pour la santé et pour qu'ils durent plus longtemps dans d'excellentes conditions.

Cuidado de electrodomésticos. Mantener los electrodomésticos limpios, ordenados y desinfectados es esencial para la salud y para que duren más. Es importante consultar las instrucciones de los distintos fabricantes.



MACCHIE E SPORCO

Stains and dirt. Clean up any stains or dirt quickly, before they have time to dry. Coffee, lemon juice, salt, oil, tomatoes and many other common foods can damage your kitchen.

Taches et saleté. Nettoyez le plus rapidement possible la cuisine. Évitez de laisser les taches sécher ou la saleté s'incruster. Le café, le jus de citron, le sel, l'huile, la tomate et beaucoup d'autres aliments d'usage quotidien endommagent la cuisine.

Manchas y suciedad Limpie la cocina con prontitud, no deje que las manchas y la suciedad se sequen. El café, el zumo de limón, la sal, el aceite, el tomate y muchos otros productos cotidianos dañan la cocina.



TOP, RUBINETTI E LAVABO

Tops, tapware and sinks. Dry the top when water is splashed onto it accidentally. Dripping water, infiltrations and limescale can damage your kitchen.

Plan de travail, robinets et évier. Essuyez tout de suite le plan de travail quand il y a de grosses quantités de liquide. Le ruissellement ou les infiltrations d'eau et le calcaire endommagent la cuisine.

Encimera, grifos y fregadero. Seque la superficie donde el agua puede haber caído accidentalmente. Goteo, infiltración de agua y cal dañan la cocina.



TOP E TAVOLI INTEGRATI

Integrated tops and tables. Although many materials boast a high resistance to heat, avoid placing red hot pots, pans and utensils on worktops as these may damage them.

Plan de travail et plan repas. Afin qu'ils durent plus longtemps, évitez de poser des casseroles ou des ustensiles bouillants sur le plan de travail ou le plan repas, même si de nombreux matériaux ont une bonne résistance à la chaleur.

Encimera y mesas integradas. No coloque ollas y utensilios calientes sobre la encimera para que dure más, aunque muchos materiales tienen buena resistencia al calor.

Conseils et entretien. Prenez soin de votre cuisine
Consejos y mantenimiento. Cuida tu cocina.



CASSETTI, CESTONI E RIPIANI

Drawers, deep drawers and shelves. Do not overload drawers, deep drawers and shelves. Try to distribute the weight evenly.

Tiroirs, casseroles et tablettes. Évitez de surcharger les tiroirs, les casseroles et les tablettes intérieures et distribuez les poids de manière uniforme.

Cajones, gavetas y baldas. Evite sobrecargar los cajones, las gavetas y baldas y distribuya los pesos de manera uniforme.



PULIZIA ANTE E PENSILI

Cleaning doors and wall units. To clean doors and wall units use a soft, damp cloth and some neutral detergent. Dry immediately. Do not use acids, aggressive detergents, solvents or abrasive sponges.

Entretien des portes et des éléments hauts. Pour le nettoyage des portes et des éléments hauts, utilisez un chiffon doux humide et un produit de nettoyage neutre. Essuyez immédiatement. N'utilisez pas d'acides, de produits de nettoyage à base forte, de solvants ni d'éponges abrasives.

Limpieza de puerta y colgantes. Para la limpieza de puertas y colgantes use un paño suave humedecido y detergente neutro. Seque enseguida. No utilice ácidos, detergentes con bases fuertes o disolventes ni esponjas abrasivas.



CORRETTO UTILIZZO DELLA LAVASTOVIGLIE

How to use your dishwasher. Let your dishwasher cool down at the end of the wash cycle before opening the door. The steam that comes out of it may damage the kitchen over time.

Usage correcte du lave-vaisselle. Laissez refroidir le lave-vaisselle à la fin du cycle de lavage. La vapeur qui se dégage pourrait à la longue endommager les meubles de cuisine.

Uso adecuado del lavavajillas. Deje que el lavavajillas se enfríe al final del ciclo de lavado. El vapor que desprende, con el tiempo podría dañar la cocina.



PULIZIA DELL' ACCIAIO INOX

Cleaning stainless steel. Use specific products to clean stainless steel. Vinegar is good at getting rid of stubborn stains. Do not use steel scouring pads or other abrasive materials as these will scratch stainless steel surfaces.

Entretien de l'acier inox. Pour le nettoyage de l'acier inox, utilisez des produits spécifiques et éliminez les taches tenaces avec du vinaigre. N'utilisez jamais de paille de fer ni d'autres matériaux abrasifs qui pourraient rayer la surface.

Limpieza de acero inoxidable. Para limpiar el acero inoxidable, use productos específicos, elimine las manchas persistentes con vinagre. No use lana de acero ni otros materiales abrasivos que rayen.



EVITARE PULITORI A VAPORE

Do not use steam cleaners. Do not use steam cleaners because steam may cause dilation of some kitchen panels.

Évitez les nettoyeurs vapeur. Évitez d'utiliser les nettoyeurs vapeur. La vapeur peut faire gonfler les meubles de la cuisine.

Evite los limpiadores a vapor. Evite el uso de limpiadores a vapor. El vapor puede hacer que los elementos de la cocina se hinchen.



COME USARE LA CAPPA

How to use the cooker hood. Turn the cooker hood on each time you cook. In the long run, smoke and steam may damage your kitchen.

Comment utiliser la hotte? Allumez toujours la hotte à chaque fois que vous cuisinez. La fumée et la vapeur de cuisson pourraient à la longue endommager la cuisine.

Cómo usar la campana. Encienda la campana cada vez que cocine. El humo y los vahos a lo largo del tiempo pueden dañar la cocina.



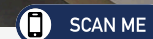

Stosa guarda al futuro

Entra nel nostro Virtual Showroom. Stosa vuole accoglierti nel suo showroom come si riceve un amico a casa propria, accompagnandoti in un percorso che sia per te fonte di ispirazione. Contaminarsi di idee è il miglior modo per capire cosa si desidera e per progettare l'ambiente più importante della casa: la cucina. Scopri tutti i dettagli unici delle cucine Stosa, clicca sugli info point per accedere a tanti contenuti multimediali, esplora lo spazio virtuale e trova lo stile giusto per vestire il tuo spazio.

Vivi la tua cucina Stosa prima che diventi realtà. Virtuo è un software ideato da Tesy, leader nello sviluppo di applicazioni per il mondo dell'arredo, che permette di trasformare il progetto della cucina in realtà virtuale e consente di interagire con lo scenario realizzato, cambiarne colori e finiture e valutarne l'impatto estetico, anche in base all'intensità della luce solare che entra nella stanza. Nei punti vendita Stosa, arredare l'ambiente cucina sarà un'esperienza sempre più coinvolgente e immersiva.

Visit our Virtual Showroom. We at Stosa would like to welcome you to our showroom just like you would invite a friend into your home. We will accompany you during your visit and we are sure that it will be a source of inspiration for you. Letting in new ideas is the best way to find out what you really want and to plan the most important room in a home: the kitchen. Check out all the unique details of Stosa kitchens, click on the info points to access lots of multimedia content and explore our virtual spaces to find the right style for your home.

Experience your Stosa kitchen before taking it home. Virtuo is a software developed by Tesy - a leader in making applications for the furniture industry - that lets you transform your kitchen project into a virtual reality with which you can interact, changing colours and finishes and checking its aesthetic impact, even based on the intensity of the natural sunlight shining into the room. When you walk into a Stosa store you will discover that furnishing your kitchen has become an increasingly more exciting and involving experience.

Entrez dans notre Showroom Virtuel. Stosa veut vous accueillir dans son showroom comme on reçoit un ami chez soi, en vous accompagnant dans un parcours pouvant se transformer en une source d'inspiration pour vous. S'imprégner d'idées est la meilleure façon pour comprendre ce que l'on souhaite et pour concevoir la pièce la plus importante de la maison : la cuisine. Découvrez tous les détails uniques des cuisines Stosa, cliquez sur les infos points pour accéder à une multitude de contenus multimédias, explorez l'espace virtuel et trouvez le style parfait pour habiller votre espace.

Créez virtuellement votre cuisine Stosa avant qu'elle ne devienne réalité! Virtuo est un logiciel créé par Tesy, leader dans le développement d'applications pour le secteur du mobilier, qui permet de transformer le projet de la cuisine en réalité virtuelle et d'interagir avec l'agencement conçu, d'en changer les couleurs et les finitions et d'en évaluer l'impact esthétique en fonction, également, de l'intensité de la lumière qui entre par la/les fenêtre/s de la pièce. Dans les points de vente Stosa, meubler la cuisine sera une expérience captivante à 360°.

Entra en nuestra sala de exposiciones virtual. Stosa desea acogerte en su sala de exposiciones como recibiría a un amigo en su casa, acompañándote en un recorrido concebido para ofrecerte una fuente de inspiración. Abrirse a nuevas ideas es la mejor manera de entender lo que se desea realmente a la hora de proyectar el ambiente más importante de la casa: la cocina. Descubre todos los detalles de las cocinas Stosa. Haz clic en los puntos de información para acceder a sus numerosos contenidos multimedia, explora el espacio virtual y encuentra el estilo perfecto para vestir tu espacio.

Vive tu cocina Stosa antes de que se convierta en realidad. Virtuo es un software ideado por Tesy, líder en el desarrollo de aplicaciones para el mundo del mueble, que permite transformar el proyecto de cocina en realidad virtual e interactuar con el escenario creado, cambiar colores y acabados y evaluar el impacto estético, también según la intensidad de la luz solar que ingresa a la habitación. En los puntos de venta Stosa, amueblar la cocina será una experiencia cada vez más cautivante y envolvente.

GARANZIA STOSA

Una garanzia completa che non ti lascia mai solo!

Scopri tutti i vantaggi del servizio di assistenza Stosa



Assistenza garantita 5 anni



Numero dedicato sempre attivo h24, 365 giorni l'anno



Falegname qualificato a tua disposizione



Idraulico, elettricista e fabbro a tua disposizione



Intervento qualificato e immediato



Sicurezza contro gli imprevisti



Rimborso biglietto per rientro anticipato



Rimborso merci refrigerate in caso di guasto

La garanzia "5 ANNI ZERO PENSIERI" è valida per tutte le cucine consegnate da Stosa S.p.A. al rivenditore a partire dal 01/09/2018. Per maggiori informazioni rivolgersi presso il rivenditore.



Grazie alla partnership con Nobis Compagnia di Assicurazioni, azienda leader nel settore delle coperture assicurative, Stosa ti offre protezione, sicurezza e un servizio di assistenza altamente qualificato ed efficiente.

rivenditore autorizzato / authorised retailer / revendeur agréé / distribuidor autorizado



STOSA SPA
S.R.2 Cassia, Km. 149,5
53040 Radicofani (SI) Italy
Tel. +39 0578 5711
Fax +39 0578 50088
stosa@stosa.it

www.stosa.it